

**Bendix/King
Silver Crown Plus™
Avionics Systems
Pilot's Guide**

**Audio Panel Systems
Communication Transceivers
Nav/Comm Systems
Navigation Receiver
DME Systems
ADF System
Transponders**

Honeywell

The information contained in this manual is for reference use only. If any information contained herein conflicts with similar information contained in the Airplane Flight Manual Supplement, the information in the Airplane Flight Manual Supplement shall take precedence.

WARNING

Prior to export of this document, review for export license requirement is needed.

COPYRIGHT NOTICE

©1998 - 2002 Honeywell International Inc.
All rights reserved.

Reproduction of this publication or any portion thereof by any means without the express written permission of Honeywell International Inc. is prohibited. For further information contact the Manager, Technical Publications; Honeywell Business & General Aviation; One Technology Center; 23500 West 105th Street; Olathe, Kansas 66061. Telephone: (913) 782-0400.

Bendix/King Silver Crown Plus™ Avionics Systems Pilot's Guide

TABLE OF CONTENTS

| | |
|--|----|
| KMA 26 Audio Amplifier/Intercom/Marker Beacon Receiver | 1 |
| KMA 28 Audio Amplifier/Intercom/Marker Beacon Receiver | 5 |
| KY 196A, KY 197A and KY 196B VHF Communications Transceivers | 11 |
| KX 155A and KX 165A VHF Communication/Navigation Transceiver | 15 |
| KN 53 Silver Crown TSO'd Navigation Receiver | 23 |
| KN 62A and KN 64 TSO'd Silver Crown Digital DMEs | 25 |
| KR 87 Silver Crown ADF System | 27 |
| KT 76C Bendix/King Panel-Mounted Transponder | 31 |
| KT 70 and KT 71 Panel-Mounted Transponders | 33 |
| KT 73 Mode S, Datalink Transponder | 37 |

ATTENTION

The operation of the GPS Navigation, Multi-Function Display and/or Traffic Information Services components of your particular Silver Crown Plus System are covered in separate publications. Choose the publication pertaining to your installation from the list below:

| <u>Description</u> | <u>Publication Part Number</u> |
|------------------------------------|---------------------------------------|
| KMD 150 Multi-Function Display/GPS | 006-18220-0000 |
| KLN 94 GPS Navigation System | 006-18207-0000 |
| KLN 89B GPS Navigation System | 006-08786-0000 |
| KLN 90B GPS Navigation System | 006-08772-0000 |
| KMD 550/850 Traffic Addendum | 006-18238-0000 |

KMA 26

Audio Amplifier/Intercom/Marker Beacon Receiver

KMA 26 Operation

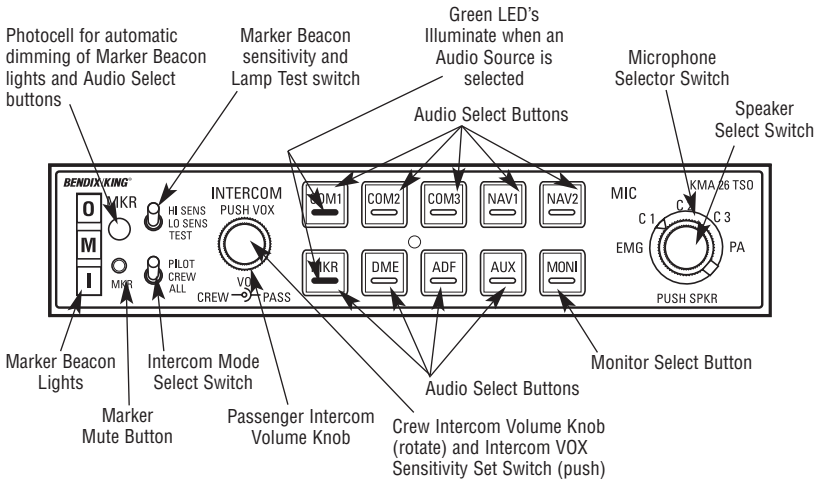

KMA 26 Control Function

Transmitter and Automatic Receiver Selection

The Microphone Selector Switch is a rotary switch used to select the desired transmitter for the cockpit microphones. The "C1", "C2", and "C3" positions are for transmitting on the Com 1, Com 2, and Com 3 communications transceivers, respectively. The "EMG" (emergency) position is used to bypass the KMA 26's audio amplifier and directly connects Com 1 to the pilot's microphone and headphones. This provides a fail-safe method of communication should the unit fail. The "PA" position may be selected when the aircraft is configured with the KMA 26 driving a dedicated passenger address speaker.

The KMA 26 has an "Auto Com" feature which always provides automatic headphone audio selection to match the Com transmitter in use. Thus, you may change the Microphone Selector

Switch without having to reselect the corresponding Com receiver button in order to hear the receiver. For example, if "C1" is selected on the Microphone Selector Switch, you will receive transmissions on Com 1 through headphones and also transmit on Com 1 when you key the mic. Notice that as you rotate the Microphone Selector Switch from "C1" to "C2" to "C3", the bottom of the respective Audio Select Button displays a green illumination to show that the corresponding receiver has been selected. To add speaker audio simply push the Speaker Select Switch (inner right knob) to the "in" position. Pulling the switch to the "out" position removes speaker audio.

Additional Receiver Selection

In addition to the receiver selected by the "Auto Com" feature described above, other receivers may be selected by pushing the corresponding Audio

Select Buttons. Push button audio selection is available for three Communications receivers ("COM1", "COM2", and "COM3"), two Navigation receivers ("NAV1" and "NAV2"), the internal Marker Beacon receiver ("MKR"), one DME, one ADF, and one additional auxiliary receiver ("AUX"). The "AUX" position could be used, for example, for a second DME or ADF. When a receiver's audio is selected, the green annunciator illuminates at the bottom of the button. Push the button again to deselect the receiver's audio. Volume for receivers is adjusted from the individual receiver itself, not from the KMA 26. Note that some receivers such as DME and marker beacon ("MKR") may not have volume adjustments available to the pilot but these radios usually may be adjusted at an Honeywell Sales and Service Center.

Monitor Function

With the Monitor ("MONI" button) function activated, if Com 1 is selected on the Microphone Selector Switch then Com 2 audio is automatically routed to the speaker. Likewise, if Com 2 is selected on the Microphone Selector Switch then Com 1 audio is routed to the speaker. This feature may be used, for example, if you are listening to ATC on Com 1 through the headphones and wish to monitor ATIS information from Com 2 in the background through the speaker. With the Microphone Selector Switch in the Com 1 position for ATC communications, pressing the "MONI" button routes Com 2 (tuned to ATIS) audio through the speaker. Pressing the "MONI" button again will disable the feature.

When the Monitor function is initially selected, the green annunciators in the "MONI" button and in the button for the Com being monitored flash for approximately five seconds. At the end of this time the "MONI" annunciation remains on steady while the Com annunciation returns to its previous state (usually off). The Monitor function is only

usable when Com 1 or Com 2 is selected on the Microphone Selector Switch.

Marker Beacon Receiver

The complete TSO'd three-light marker beacon receiver built into the KMA 26 gives you an accurate visual and aural signal when you pass over a 75 MHz beacon. The blue, amber, and white lights on the faceplate, as well as the audio tones, identify the beacon type (outer, middle, or inner/airway marker, respectively).

The "MKR" Audio Select button must be pushed so that the green annunciator is illuminated for the marker beacon receiver to provide an audio signal at beacon passage. The toggle switch on the upper left side on the faceplate provides the choice of two receiver sensitivities. When the switch is in the "HI SENS" (upper) position the high sensitivity is selected which permits you to hear the outer marker tone about a mile from the marker beacon transmitter. At this point you may select the "LO SENS" (middle) position to temporarily silence the tone. It will start to sound again when you are closer to the marker, giving you a more precise indication of its location. Many pilots choose to leave the switch in the low sensitivity position.

Holding the toggle switch in the "TEST" position simply applies voltage to all three marker lamps in the unit and any external marker lights. The "TEST" position is spring loaded so that when the toggle switch is released it returns to the "LO SENS" position.

The photocell in the faceplate automatically dims the marker lights as well as the green annunciators in the Audio Select Buttons for night operation.

When marker audio is heard, the pilot may momentarily push the Marker Mute Button, if desired, to silence the marker audio while the aircraft is passing over this marker beacon. The marker audio will automatically be reset so that it will be heard when passing

over the next marker beacon. The Marker Mute Button has no effect on the Marker Beacon Lamps.

Intercom

The KMA 26 contains a very versatile built-in six station intercom. Intercom operation is normally installed to be voice activated (VOX), where the intercom becomes active automatically when a crew member or passenger begins to speak. It may optionally be installed for keyed activation, where a separate microphone switch must be keyed to activate the intercom.

In order to set the proper VOX sensitivity, momentarily press and release the left inner knob when no one is speaking into their microphones. The VOX sensitivity should be set if a background hissing sound is heard in the headphones or if intercom communications are "clipped", i.e. the first syllable is lost during intercom operation. The VOX sensitivity may need to be reset when there is a large change in the noise level in the cockpit or cabin. The VOX level should also be reset each time power is applied to the KMA 26.

NOTE: To properly set the VOX sensitivity make sure that no one is speaking into the microphone. The pilot may wish to put the intercom in the "ALL" position to ensure that there is no microphone activity before momentarily pushing the left inner knob. In addition, make sure that none of the microphones are in a position to pick up extraneous noise such as wind

noise from an open window/vent or vibration from laying on an instrument panel or against a window. It is highly recommended that any unused headsets be unplugged.

The intercom has three modes: "ALL", "CREW", and "PILOT," which are selected with the toggle switch on the lower left side of the faceplate. In the "ALL" position the pilot, copilot and passengers are all on the same intercom "loop" and everyone hears the radios. In the "CREW" position the pilot and copilot are on one intercom loop and can hear the radios while the passengers have their own dedicated intercom and do not hear the radios. In the "PILOT" mode the pilot hears the radios but is isolated from the intercom while the copilot and passengers are on the same intercom loop and do not hear the radios.

When either the "ALL" and "CREW" intercom modes are selected, the pilot's and copilot's intercom volume is controlled by rotating the Crew Intercom Volume Knob (left inner knob) while the passenger's volume is controlled by rotating the Passenger Intercom Volume Knob (left outer knob). When the "PILOT" intercom mode is selected, the copilot's and passenger's volume is controlled with the Passenger Intercom Volume Knob. Remember, the volume knobs on the KMA 26 control intercom volume only, not the receivers' volume.

Auxiliary Music Inputs

The KMA 26 can accommodate two music inputs for the listening enjoyment of crew and passengers. The music input is muted quickly when radio communications are received and then gradually returns to its previous volume. The KMA 26 can also be config-

ured at the time of installation to either have or not have the music be muted by intercom conversation. Table 1 outlines music input operation during the three intercom modes for a system having two music inputs. If there is only one music source it is usually installed as music 1 but it may be wired as either music 1 or music 2.

| INTERCOM MODE | PILOT HEARS | COPILOT HEARS | PASSENGERS HEAR |
|---------------|-------------|---------------|-----------------|
| PILOT | NO MUSIC | MUSIC #1 | MUSIC #1 |
| CREW | MUSIC #2 | MUSIC #2 | MUSIC #1 |
| ALL | MUSIC #1 | MUSIC #1 | MUSIC #1 |

Intercom Mode

KMA 28

Audio Amplifier/Intercom/Marker Beacon Receiver

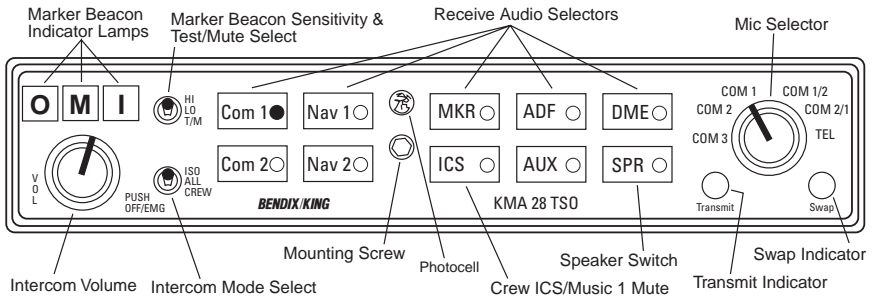

KMA 28 Control Function

KMA 28 Operation

Receive Audio Selectors

Receiver audio is selected through two momentary and six latched, push-button, backlit switches. Com 1 and Com 2 are the momentary switches.

Because the rotary microphone selector switch controls what transceiver is being heard, the Com 1 and Com 2 push-buttons are of the momentary type and do not remain in when selected. This is also part of the "auto" function. You will always hear the audio from the transceiver that is selected for transmit by the rotary mic selector switch.

The users can identify which receivers are selected by noting which of the green switch LEDs are illuminated. Push buttons labeled Nav 1, Nav 2, DME, MKR (Marker), ADF, AUX (auxiliary), and SPR (Speaker) are "latched" type switches. When one of these buttons is pressed, it will stay in the "in" position. Press the switch again and it be in the "out" position and remove that receiver from the audio.

Key "click"

The KMA 28 is equipped with an electronic "click" to provide additional feedback for button operation. To activate the key click, push and hold BOTH COM 1 and COM 2 receiver buttons for five seconds, and release. Repeat to defeat the click.

Speaker Amplifier

The "SPR" in the push-button section stands for speaker. This switch will place all selected audio on the cockpit speaker when this switch is selected.

Public Address (PA) Function

The KMA 28 has a public address capability when an optional external PA switch is installed. When this switch is put into the PA position, the pilot's microphone is placed on a speaker output. The copilot can continue to use the selected Com radio.

When this PA function is installed a separate cabin speaker (rather than the cockpit speaker) is usually utilized to prevent feedback.

Power Switch /Emergency (EMG) Operation

Unit power is turned on and off by pushing the volume knob. In the off or "Emergency" position, the pilot is connected directly to Com 1. This allows communication capability regardless of unit condition. Any time power is removed or turned off, the audio selector will be placed in the emergency mode.

The power switch also controls the audio selector panel functions, intercom, and marker beacon receiver. Unless the mic selector is in Com 3 mode, at least one of the selected audio LEDs will be on (Com 1 or Com 2).

Microphone Selector

When the mic selector switch is in the Com 1 position, both pilot and copilot will be connected to the Com 1 transceiver. Only the person who presses their Push To Talk (PTT), will be heard over the aircraft radio. Turning the rotary switch to the Com 2 position will place pilot and copilot on Com 2.

The KMA 28 gives priority to the pilot's PTT. If the copilot is transmitting, and the pilot presses his PTT, the pilot's microphone will be heard over the selected com transmitter.

Turning the mic selector fully counterclockwise places the pilot and copilot on Com 3. Com 3 receive audio is automatically placed in the headset (and speaker if selected). Com 1 and/or Com 2 receiver audio can be selected to monitor those transceivers.

The KMA 28 has an automatic selector mode. Audio from the selected transceiver is automatically heard in the headsets and speaker. You can check this function by switching from Com 1 to Com 2 and watch the selected audio light on the selector change from COM 1 to COM 2. This ensures the pilot will always hear the audio from the trans-

ceiver he is transmitting on.

When transmitting, the COM 1 or COM 2 LED in the KMA 28 audio selector will blink as a further indication of the selected transmitter.

When switching the mic selector rotary switch from Com 1 to Com 2, while Com 2 audio had been selected, Com 1 audio will continue to be heard. This eliminates the pilot having to switch Com 1 audio back on, if desired.

When switching from Com 1 to Com 2 while Com 2 has NOT been selected, Com 1 audio will be switched off. In essence, switching the mic selector will not effect the selection of Com audio.

Swap Mode (Switch from Com 1 to Com 2 remotely)

With an optional yoke mounted, momentary switch, the pilot can change from the current Com transceiver to the other by depressing this switch. When "Swap Mode" is active, an annunciator in the lower right corner of the unit will illuminate, indicating that the mic selector switch position is no longer current. To cancel "Swap Mode," the pilot may either press the yoke mounted switch again, or turn the mic selector switch to the Com that is active.

Split Mode

Turning the rotary switch to Com 1/Com 2 places the KMA 28 into "Split Mode." This places the pilot on Com 1 and the copilot on Com 2. An example of this useful feature is when the pilot may want to talk to Air Traffic Control, while the copilot may be speaking to Flight Watch. Although this mode has limitations (see below) we believe you will find this to be a useful feature.

Switching to Com 2/Com 1 will reverse the "Split Mode" radio selection. The pilot will be on Com 2 and the copilot will be on Com 1.

Note: Due to the nature of VHF communications signals, and the size constraints

in general aviation aircraft, it is probable that there will be some bleed-over in the Split mode, particularly on adjacent frequencies. In addition, if the Com radios in the installation utilize a "transmit interlock" system, the split mode may not work properly unless the interlock feature is disabled.

Note: Honeywell makes no expressed or implied guarantee regarding the suitability of Split Mode in a given installation.

Note: Split Mode does not turn off other (Nav, ADF, etc.) selected audio to pilot. However, the copilot will only hear the selected communications receiver and unswitched audio.

Split Mode ICS

In split mode, the pilot and copilot are isolated from each other on the intercom, simultaneously using their respective radios. Depressing the ICS button in Split Mode will activate VOX intercom between the pilot and copilot positions. This permits intercommunication when desired between the crew. Pressing the ICS button again disables this crew intercom function.

Telephone Mode

The "TEL" position, fully CW on the mic selector switch, is the pilot's "hook" switch. This is active only when the system is interfaced to an appropriate approved system, such as the AirCell™ system. Placing the mic selector in TEL places the pilot microphone and headphones on the cellphone. The pilot PTT will switch the pilot mic to the COM 1, and allow continued aircraft communications as well.

NOTE: Placing the mic selector switch in the TEL position will disable pilot and copilot intercom, as the intercom circuit is transferred to the telephone use. In crew or ISO mode, placing the switch in TEL mode removes the passengers access to the telephone.

If interface is desired with another type of wireless telecommunications unit, the aircraft owner can purchase an after-market interface cable. By Federal Communications Commission (FCC) regulations, these can only be used on the ground in the United States.

Interface cables are available for specific telephones. The following is a partial list of available interface cables:

Compatible Phones

Audiovox Series 5

Motorola TeleTAC, DPC 550, DPC65-

, Lite Series, Profile Series

Motorola Elite, M70, M75, SC-725

Motorola Bag Phones, Mobiles

NEC100 Series, 110, 120, 180, Sport

NEC 700 & 800 Series

OKI 900/910, AT&T 3730/3710

OKI 1150/1145, AT&T 3760

Fujitsu PCX

Mitsubishi 4000, DiamondTel

22X/20X/18X

NEC960

NEC DT2000 Digital Phone

NOTE: Unauthorized use of cellular telephone devices in aircraft is subject to FCC enforcement action, which may include a \$10,000 fine per incident. Honeywell, Inc. does not endorse using unapproved cellular telephone equipment in flight, and takes no responsibility for the user's action.

Intercom System

‡ IntelliVox™ VOX-Squelch

No adjustment of the IntelliVox™ squelch control is necessary. Through three individual signal processors, the ambient noise appearing in all six microphones is constantly being sampled. Non voice signals are blocked. When someone speaks, only their microphone circuit opens, allowing him or her to communicate on the intercom.

‡ IntelliVox™ is a registered trademark of PS Engineering, Inc. and is used by permission.

The system is designed to block continuous tones; therefore people humming or whistling in monotone may be blocked after a few moments.

For best performance, the headset microphone must be placed within $^{\circ}$ inch of your lips, preferably against them. It is also a good idea to keep the microphone out of a direct wind path. Moving your head through a vent air stream may cause the IntelliVox™ to open momentarily. This is normal.

For optimum microphone performance, Honeywell recommends installation of a Microphone Muff Kit from Oregon Aero (1-800-888-6910). This will not only optimize VOX acoustic performance, but will improve the overall clarity of all your communications.

Volume Control

The volume control knob adjusts the loudness of the intercom for the pilot and copilot only. It has no effect on selected radio levels, music input levels or passengers' volume level.

Adjust the radios and intercom volume for a comfortable listening level for the pilot. Most general aviation headsets today have built-in volume controls; therefore, passenger volume can be adjusted at the headset.

Mono headsets in Stereo Installation

All passenger headsets are connected in parallel. Therefore, if a monaural headset is plugged in to a Stereo KMA 28 installation, one channel will be shorted. Although no damage to the unit will occur, all passengers will lose one channel.

Intercom Modes

The lower switch on the left side is a 3-position mode switch that allows the pilot to tailor the intercom function to best meet the current cockpit situation.

ISO: (Up Position): The pilot is isolated from the intercom and is connected only to the aircraft radio system. He will hear the aircraft radio reception (and sidetone during radio transmissions). Copilot will hear passengers' intercom and Entertainment 1, while passengers will hear copilot intercom and Entertainment 2. Neither will hear aircraft radio receptions or pilot transmissions.

ALL: (Middle Position): All parties will hear the aircraft radio and intercom. Crew will hear Entertainment 1, passengers will hear Entertainment 2. During any radio or intercom communications, the music volume automatically decreases. The music volume increases gradually back to the original level after communications have been completed.

CREW: (Down Position): Pilot and copilot are connected on one intercom channel and have exclusive access to the aircraft radios. They may also listen to Entertainment 1. Passengers can continue to communicate with themselves without interrupting the Crew and also may listen to Entertainment 2.

Anytime the KMA 28 is in either the Com 1/Com 2, Com 2/Com 1, ("Split Mode"), the pilot and copilot intercom is controlled with the ICS button. The passengers will maintain intercommunications, but never hear aircraft radios.

Entertainment Input

The audio selector panel has provisions for two separate entertainment input devices. They operate independently in the KMA 28. The volume control does not affect music level.

While in the ISO (Isolate) mode, the copilot will hear Entertainment 1 while the four passengers will hear Entertainment #2. The pilot will hear Entertainment 1 at a level muted about 95%. In normal operation, whenever a person speaks, or if the aircraft radio becomes active, the music will auto-

matically mute and then will gradually return to the original listening level when the intercom or radio conversation ceases.

When in the All mode, pilot and copilot will hear Entertainment 1 input while all passengers will hear the Entertainment 2 source. While in the Crew mode, pilot and copilot will hear entertainment input #1 while the passengers may listen to entertainment input #2.

Soft Mute and Soft Mute inhibit

The Soft Mute feature assures that the aircraft radio transmissions will not be missed due to entertainment playing. When there is radio reception or intercom conversation, the music level is dropped to a background level. When the radio or intercom traffic ceases, the level gradually returns to normal.

The front panel ICS switch controls muting of entertainment source #1. Pushing this button places the ICS in Karaoke (or sing along) mode, which inhibits the soft mute feature. This allows the music to continue uninterrupted by intercom or radio traffic when cockpit workload is appropriate. Pushing the button again will release the mute inhibit function.

The passenger music, source #2, can be placed in the Karaoke mode if a remote switch is installed in the aircraft..

Marker Beacon Operation

The Marker Beacon Receiver uses visual and audio indicators to alert you when the aircraft passes over a 75 MHz transmitter.

The audio from the Marker Beacon Receiver can be heard by selecting the

| Mode | Pilot Hears | Copilot Hears | Passenger Hears | Telephone | Comments |
|----------------|--|---|---|---|--|
| Isolate | A/C Radios Pilot Sidetone (during radio transmission) Entertainment 1 is Muted | Copilot and passenger intercom Entertainment #1 | Passenger and Copilot intercom Entertainment #2 | "Phone Booth" mode Pilot has exclusive use of the telephone. In TEL, Pilot connected to Com 1 for PTT TX and receive. | This mode allows the pilot to communicate without the others bothered by the conversations. Copilot and passengers can continue to communicate and listen to music |
| All | Pilot Copilot A/C Radio Passengers Entertainment #1 | Copilot Pilot A/C Radio Passengers Entertainment #1 | Passengers Pilot Copilot A/C Radio Entertainment #2 | All have access to phone through Hook Switch. Pilot access through TEL switch. All hear telephone audio. | This mode allows all on board to hear radio reception as well as communicate on the intercom. Music and intercom is muted during intercom and radio communications |
| Crew | Pilot Copilot A/C Radio Entertainment #1 | Copilot Pilot A/C Radio Entertainment #1 | Passengers Entertainment #2 | Pilot and copilot don't have phone access, unless mic sel in TEL. Passengers have phone through Hook Switch, Passengers hear phone audio. | This mode allows the pilot and copilot to concentrate on flying, while the passengers can communicate amongst themselves. |

Intercom Modes

"MKR" push-button switch.

A three-position switch is used to set the receiver sensitivity and to test the indicator lamps. Use "High" sensitivity initially. This allows you to hear the outer marker beacon about a mile out. Then select the "Low" sensitivity to give you a more accurate location of the Marker. When used only for approach markers, many pilots choose to leave the switch in the low sensitivity position.

The momentary down switch position is labeled "T/M" (Test/Mute) and illuminates all three lamps simultaneously to assure they are in working order.

The "T/M" position is also a Marker Beacon "Mute" function. Pushing this switch while receiving a marker beacon signal will cause the audio to be temporarily silenced. No action is required to restore the audio in time for the next beacon.

Telephone Operation (if equipped with approved system)

Each intercom position has a "hook switch." The pilot's hook switch is the "TEL" mode on the mic selector, the others are individual switches mounted adjacent to the headset jacks.

When the intercom is in ALL mode, the pilot can speak on the phone only if the mic selector switch is in TEL position. All intercom positions will hear the telephone conversation. Anyone who places his or her switch into the "off-hook" position will also be heard on the phone. All will hear selected audio. Com 1 audio is automatically heard in the headsets. The pilot will have transmit capability on Com 1, simply by using the PTT switch.

In CREW mode, the pilot and copilot may use the telephone, with their respective hook switch (the pilot selects TEL on the mic selector). Any passen-

ger who places their switch into the off-hook position will also have access to the phone, and all four passengers will hear the conversation.

In ISO intercom mode, when the KMA 28 is in the TEL mode, the pilot position is in the "Phone Booth." Only the pilot will hear the telephone, and only he will be heard. He will also have access to Com 1, and will transmit on that radio using the PTT. All selected audio is provided.

In all cases, only the pilot (and copilot in ALL or CREW) will hear the cell-phone ring. At that time they can choose to allow a passenger to take the call, or answer the phone.

Note: Because the phone uses an intercom circuit, all stations on that circuit will lose intercom capability when it is in use.

KY 196A, KY 197A and KY 196B VHF Communications Transceivers

KY 196A, KY 197A and KY 196B Operation.

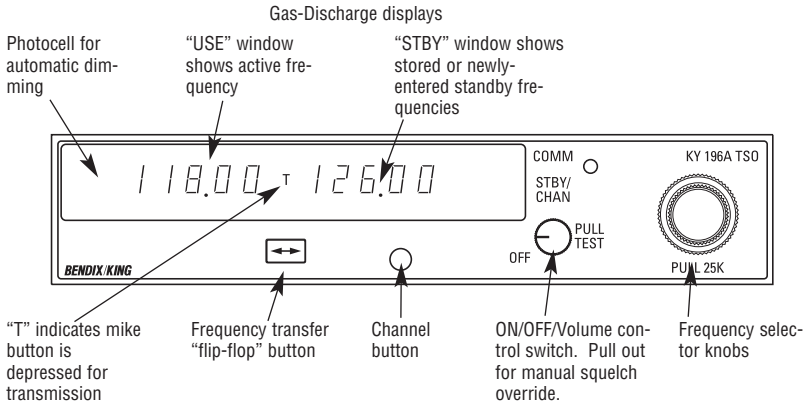

KY 196A/197A

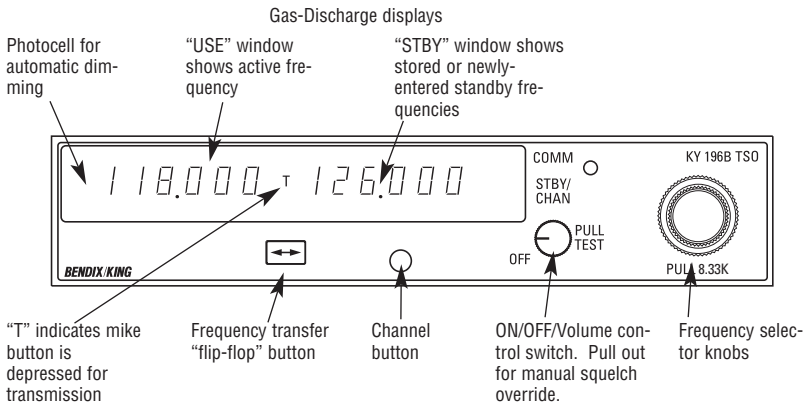

KY 196B

Power up

When you turn the ON/OFF/Volume knob clockwise to the "ON" position, your unit will display the frequencies last used in the "USE" and "STBY" (standby) windows.

To override the automatic squelch, pull the ON/OFF/Volume knob out and, judging by static noise, rotate it to the

desired volume level. Push the knob back in to activate the automatic squelch.

NOTE: As with all avionics, the KY 196A, KY 197A and KY 196B should be turned on only after engine startup. This simple precaution will help protect the solid-state circuitry and extend the operating life of your equipment.

Transmitting

During COMM transmissions, a “T” will appear between the “USE” and “STBY” windows to indicate the keying of the microphone.



KY 196A/197A Frequency Mode (Normal Operation)

1. Select a new frequency in the “STBY” window, using the frequency selection knobs. The larger knob controls changes in increments of 1MHz. The smaller knob controls changes in increments of 50kHz when pushed in, and 25kHz when pulled out.

At the outside limits of the band, the display will “wrap around” to the other end of the band, going from 136MHz to 118MHz.

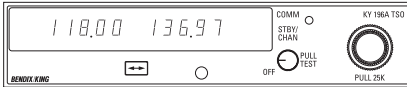

2. Press the transfer button to activate the new frequency. The newly entered frequency in the “STBY” window flip-flops with the frequency in the “USE” window. This new frequency is now available for use. An optional remote-mounted frequency transfer button may also be used to perform this “flip-flop” function.

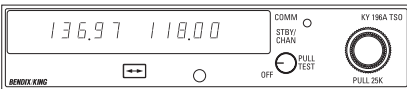

KY 196B Frequency Mode (Normal Operation)

1. Select a new frequency in the “STBY” window, using the frequency selection knobs. The larger knob controls changes in increments of 1MHz. The smaller knob allows selection of 25kHz frequencies only when pushed in, and both 8.33kHz and 25kHz frequencies when pulled out.

At the outside limits of the band, the display will “wrap around” to the other end of the band, going from 136MHz to 118MHz.

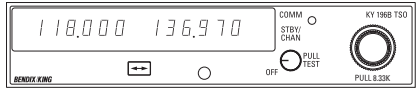

2. Press the transfer button to activate the new frequency. The newly entered frequency in the “STBY” window flip-flops with the frequency in the “USE” window. This new frequency is now available for use. An optional remote-mounted frequency transfer button may also be used to perform this “flip-flop” function.

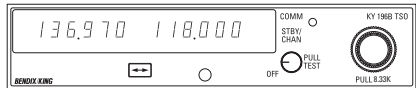

Program Mode

The Program Mode is used to program frequencies for use in the Channel Mode.

1. Depress the channel (CHAN) button for more than two seconds, until the channel number (to the right of the standby frequency) begins flashing. The most recently used active frequency will remain displayed in the “USE” window.

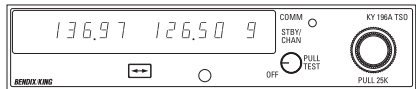

2. Turning either frequency selection knob will change the channel.

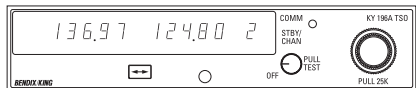

3. Once you've selected the desired channel number, you may program a new frequency by pressing the transfer button. This will cause the frequency in the “STBY” window to flash. The tuning knobs are now used to enter desired frequency.

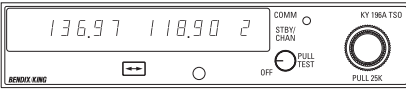

4. To program additional channels, push the transfer button again to make the channel number flash, and repeat step three above.

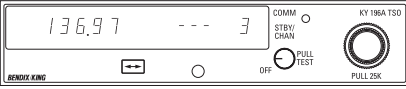

5. If you wish to program fewer than nine channels while skipping certain channel numbers, rotate the MHz frequency knob left or right beyond 136MHz or 118MHz. Dashes (---) will appear in the "STBY" window, indicating that the channel will be skipped when the system is operating in the Channel Mode.



6. To exit the Program Mode, momentarily press the channel button. The unit will also automatically exit the Program Mode if no programming occurs within approximately 20 seconds.

The Program-Secure Mode

The Program Secure Mode may be used to lock a desired frequency to a specific channel number, prohibiting program changes from the front of the unit. Your KY 196A, KY 197A or KY 196B should be taken to your Bendix/King dealer for programming in the Program Secure Mode.

Channel Mode

The Channel Mode is used to recall preset frequencies stored in memory.

1. To enter the Channel Mode momentarily, push the channel button while in the Frequency Mode. The active frequency remains displayed in the "USE" window, and the last used channel number and its associated frequency

are displayed in the "CHAN" and "STBY" windows.



If no channels have been programmed, channel 1 automatically disappears and dashes are displayed in the "STBY" window.

2. Turn either frequency selection knob to change the channel number and the channel's corresponding frequency in the "STBY" window.



3. If there is no activity for five seconds, the radio will exit the Channel Mode and return to the Frequency Mode, with the channel frequency remaining in the "STBY" window.



4. You can also return to the Frequency Mode by either:

- Pressing the channel button before the five-second delay, in which case the radio recalls the "USE" and "STBY" frequencies prior to entering the Channel Mode, or
- Pressing the transfer button, so that the channel frequency becomes the active frequency and the last "USE" frequency becomes the new "STBY" frequency.

NOTE: If the optional remote channel increment switch is installed, each activation of the switch will put the unit in the Channel Mode and advance the channel number from the previous channel used.

Direct Tune Mode

The Direct Tune Mode is entered by pressing and holding the transfer button for longer than two seconds. The

“STBY” frequency will disappear and the frequency in the active window can be changed with the frequency selection knobs.



Momentarily pushing the transfer button will return the unit to the Frequency Mode (normal operation). The “STBY” frequency displayed prior to entering the Direct Tune Mode will remain unchanged.



Default Mode

Turning on your KY 196A, KY 197A or KY 196B while pressing the transfer button will bring the unit up in the Direct Tune Mode and install 120.00MHz or 120.00MHz (KY 196B) as the active frequency. This will aid the pilot in blind tuning the radio in the unlikely event of display failure.

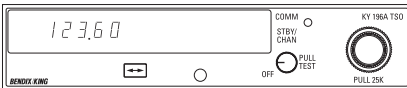

Display Adjust Modes

To enter the Display Adjust Mode, press and hold the channel button until the Program Mode is entered. Continue holding the channel button while simultaneously pressing and holding the frequency transfer button until “dA 1” replaces the frequency in the “USE” window.

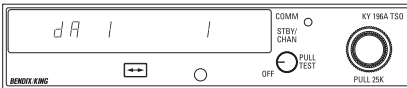

The frequency selector knobs are used to change the value in the “STBY” window. Momentarily pressing the channel button steps the unit through the Display Adjust Modes, “dA 1” through “dA 3”. Press the frequency

transfer button to exit the Display Adjust Mode.

Display Adjust 1 (dA 1) is used to vary the dim/bright response time to changes in ambient light on the display photocell. The range of values for dA 1 is 1-8, with 1 representing normal.

The normal setting, 1, provides immediate display brightness changes when there are changes in the light falling on the photocell. With dA 1 set to a value of 8, the response time is approximately eight seconds. dA 1 values of 2 through 7 provide intermediate response times.

Display adjustment 2 (dA 2) is used to vary the display brightness when ambient light conditions are less than direct sunlight, such as in a dark cockpit. dA 2 values range from 0-64, with 0 being dimmest and 64 being brightest; the normal dA 2 setting is 20.

dA 3 values range from 0 to 255, with 0 being dimmest and 255 being brightest. This adjustment varies the amount of ambient light required for the display to reach its full dim and bright levels. Normal dA 3 values for a new display range from 0 to 30.

A common use of dA 3 is to adjust the KY 196A, KY 197A or KY 196B display brightness to match the brightness of other radios' displays. Another use is to provide display brightness compensation as the display ages.

KX 155A and KX 165A VHF Communication/Navigation Transceivers

KX 155A and KX 165A Operation (25 kHz Versions)

All controls required to operate the KX 155A and KX 165A are located on the unit front panel.

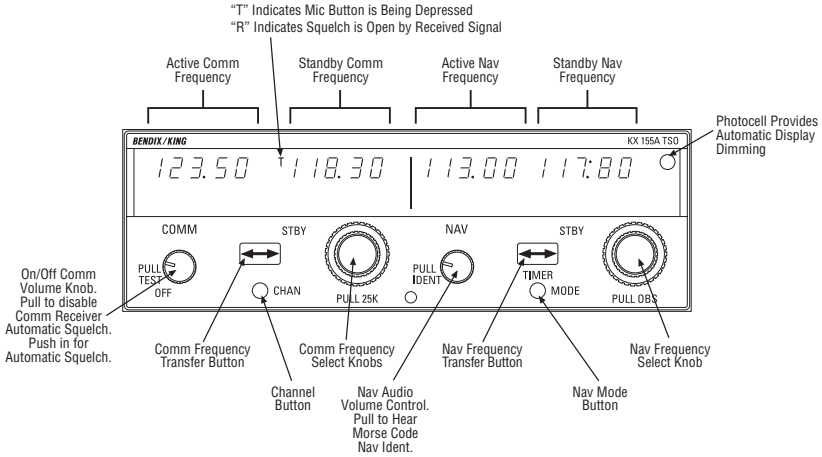

FIGURE 1A
KX 155A and KX 165A (25 kHz Versions) CONTROL FUNCTION

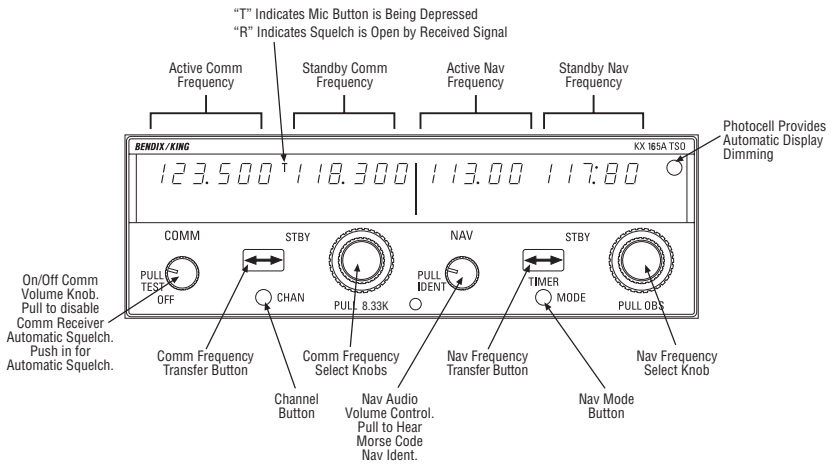

FIGURE 1B
KX 165A (8.33 kHz Versions) CONTROL FUNCTION

NOTE: The 25 kHz and 8.33 kHz versions of the KX 165A are distinguishable from one another in two ways. The 25 kHz version has "PULL 25K" nomenclature below the Comm Frequency Select Knobs while the 8.33 version has "PULL 8.33K". In addition, the 25 kHz version has two digits to the right of the decimal in the Comm frequency while the 8.33 kHz version has three digits to the right of the decimal. The 8.33 kHz channel spacing is required for flight in certain European (ICAO EUR Region) airspace.

COMM Transceiver

Rotate the VOL knob clockwise from the OFF position. Pull the VOL knob out and adjust for desired listening level. Push the VOL knob back in to actuate the automatic squelch.

The left portion of the digital display readout is allocated for COMM ACTIVE and COMM STANDBY frequencies with a "T" between them to indicate TRANSMIT and an "R" to indicate RECEIVE modes of operation.

Select the desired operating frequency in the standby display by rotating the Frequency Select Knobs either clockwise or counterclockwise. A clockwise rotation will increment the previous frequency while a counterclockwise rotation will decrement the previous frequency.

The outer knob will change the MHz portion of the standby display. At one band-edge (118 or 136 MHz) the following 1 MHz change will wrap around to the other band-edge.

KX 155A and KX 165A 25 kHz Versions

The inner knob will change the kHz portion of the standby display. It will change in increments of 50 kHz when the knob is pushed in and 25 kHz when the knob is pulled out. The frequency wrap around at the edge of the band is also utilized when incrementing or decrementing the kHz portion of the standby display.

KX 165A 8.33 kHz Version

The inner knob will change the kHz portion of the standby display. It allows selection of 25 kHz frequencies only when the knob is pushed in and both 8.33 kHz and 25 kHz frequencies when the knob is pulled out. The frequency wrap around at the edge of the band is also utilized when incrementing or decrementing the kHz portion of the standby display.

To tune the radio to the desired operating frequency, the desired frequency must be entered into the standby display (Figure 2) and then the transfer button must be pushed. This will trade the contents of the active and standby displays (Figure 3).

NOTE: An optional remote mounted transfer switch may also be installed in a convenient location (such as the control yoke) to perform the transfer operation.

The operating frequency can also be entered by accessing the ACTIVE ENTRY (direct tune) mode which is done by pushing and holding the COMM TRANSFER button for 2 or more seconds. In the direct tune mode, only the active part of the display is visible (Figure 4). The desired frequency can be directly entered into the display. Push the COMM TRANSFER button again to return to the active/standby display.

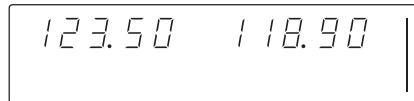

FIGURE 2
Frequency entered in
standby display

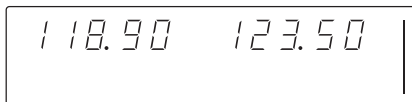

FIGURE 3
Active/standby frequencies toggle



FIGURE 4
Frequency entered in active entry mode

The transceiver is always tuned to the frequency appearing in the ACTIVE display. It is therefore possible to have two different frequencies stored in the ACTIVE and STANDBY displays and to change back and forth between them at the simple push of the transfer button.

During the transmit mode of operation, a "T" will appear between the ACTIVE and STANDBY displays. An "R" will appear between the ACTIVE and STANDBY displays if a detected signal is strong enough to open the squelch, signifying that the transceiver is in the receive mode of operation.

A non-volatile memory stores the comm ACTIVE and STANDBY frequencies on power down. When the unit is turned on again, the COMM ACTIVE and STANDBY windows will display the same ACTIVE and STANDBY frequencies that were displayed before power down.

The KX 155A and KX 165A also have provisions to program 32 channels. Pressing the CHAN button for 2 or more seconds will cause the unit to enter the channel program mode. Upon entering the channel program mode, "PG" is displayed next to the channel number and the channel number will flash indicating that it can be programmed (Figure 5).

The desired channel can be selected by turning the comm kHz knob (Figure 6). The channel frequency can be entered by pushing the COMM TRANSFER button which will cause the standby frequency to flash. The comm frequency knobs are then used to enter the desired frequency (Figure 7). If dashes (displayed when rotating the outer knob between 136 MHz and 118 MHz) are entered instead of a frequency, the corresponding channel is skipped in channel selection mode (Figure 8). Additional channels may be programmed by pressing the COMM TRANSFER button and using the same procedure. To exit the program mode and save the channel information, momentarily push the CHAN button. This will cause the unit to return to the previous frequency entry

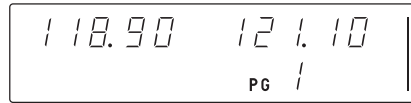

FIGURE 5
Entering channel program mode

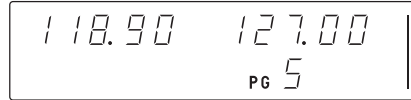

FIGURE 6
Selecting desired channel

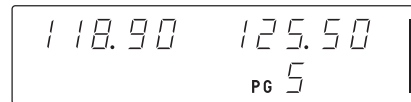

FIGURE 7
Selecting desired frequency

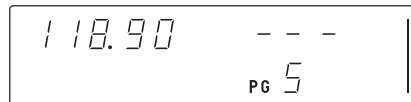

FIGURE 8
Corresponding channel is skipped in channel selection mode

Silver Crown Plus Pilot's Guide

mode. The unit will also exit the channel program mode if there is no button or knob activity for 20 seconds.

The channel selection mode can then be entered by momentarily pushing the CHAN button (Figure 9). "CH" is displayed next to the last used channel number.

NOTE: If no channels have been programmed, channel 1 appears with dashes displayed.

The comm frequency knobs can be used to select the desired channel (Figure 10). The unit will automatically exit the channel mode, with the channel frequency remaining in the STANDBY window, if no channel is selected within 5 seconds after entering the channel selection mode. The channel frequency is then made the ACTIVE frequency in the normal manner by pressing the COMM TRANSFER button.

NOTE: An optional remote mounted channel switch may be installed that increments the next programmed channel into the standby window each time the switch is activated.

The unit is placed in the transmit mode by depressing the MIC KEY button. The unit has a stuck microphone alert feature. If the microphone is keyed continuously for greater than 33 seconds, the transmitter stops transmitting and the active Comm frequency flashes to alert the pilot of the stuck microphone condition.

NOTE: Radio control of airport runway lighting is available at selected airports to provide airborne control of lights by keying the aircraft's microphone. Approved lighting systems may be activated by keying the microphone as indicated below:

7 times in 5 sec. - Highest intensity available
5 times in 5 sec. - Medium or lower intensity
3 times in 5 sec. - Lowest intensity available

Do to the close proximity of airports using the same frequency, an airport's radio controlled lighting receiver may be set at a low sensitivity, requiring the aircraft to be relatively close to activate the system. It is also important to be very deliberate with the keying. The require-

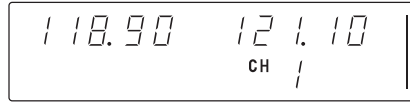

FIGURE 9
Entering channel selection mode

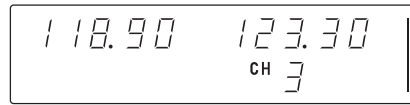

FIGURE 10
Selecting desired channel

ment for the ground station decoder is such that it will not respond to very rapid or “staccato” transmissions. If the first attempt at lighting the runway lights is unsuccessful, repeat with a slower, more deliberate cadence of microphone keying.

NAV Receiver

The right portion of the display is allocated to NAV receiver information. The frequency channeling is similar to the COMM when operating in the frequency mode (Figure 1A and 1B). The NAV increment/decrement knobs are located on the right hand side of the front panel. The outer knob operates in 1 MHz steps and increments/decrements the STANDBY frequency display.

The inner knob operates in 50 kHz steps. The NAV receiver’s lower and upper frequency limits are 108.00 MHz and 117.95 MHz. Exceeding the upper limit of frequency band will automatically return to the lower limit and vice versa.

Depressing the NAV frequency transfer button for 2 seconds or more will cause the display to go in to the ACTIVE ENTRY mode. Only the ACTIVE frequency will be displayed and it can be directly changed by using the NAV inc/dec knobs. The display will return to the ACTIVE/STANDBY mode when the NAV frequency transfer button is pushed.

Depressing the mode button will cause the NAV display to go from the ACTIVE/STANDBY format to the ACTIVE/CDI (Course Deviation Indicator) format as shown in Figure 11. The vertical “needle” moves side to side similar to a mechanical CDI. When the needle is centered, the aircraft is on the selected OBS course. When the active frequency is tuned to a VOR frequency, the center of the CDI scale displays the “TO” or “FROM” indicator.

In the CDI mode, the increment/decrement knob (pushed in) channels the ACTIVE frequency window and depressing the frequency transfer button will

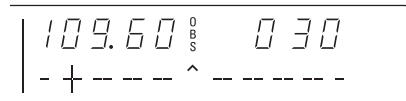

FIGURE 11
Nav display active VOR frequency/
CDI format

Silver Crown Plus Pilot's Guide

cause the ACTIVE frequency to be placed in blind storage and the STANDBY frequency (in blind storage) to be displayed in the ACTIVE window display.

When the ACTIVE window is tuned to a VOR frequency, the standby frequency area is replaced by a three digit OBS (Omni Bearing Selector) display. The desired OBS course can be selected by pulling out the inner NAV frequency knob and turning it. The CDI needle may be automatically centered with a "TO" indication by depressing the mode button for 2 seconds. This OBS display is independent of any OBS course selected on an external CDI or HSI. An "OBS" in the middle of the NAV display will flash while the inner NAV frequency knob is pulled out. The CDI is displayed on the line below the frequency/OBS.

When the ACTIVE window is tuned to a localizer frequency, the standby frequency area is replaced by "LOC" (Figure 12).

When the received signal is too weak to ensure accuracy the display will "flag". See Figure 13.

Depressing the mode button will cause the NAV display to go from the ACTIVE/CDI format to the ACTIVE/BEARING format. In the BEARING mode, the increment/decrement knob channels the ACTIVE frequency window and depressing the frequency transfer button will cause the ACTIVE frequency to be placed in blind storage and the STANDBY frequency (in blind storage) to be displayed in the ACTIVE window display. In bearing mode of operation, the right hand window of NAV display shows the bearing TO the station.

Figure 14 illustrates the NAV side of the display in this mode.

When a too weak or invalid VOR signal is received the display flags as shown in Figure 15.

Another push of the mode button will cause the NAV display to go from the ACTIVE/BEARING format to the ACTIVE/RADIAL format as shown in Figure 16. In the RADIAL mode, the

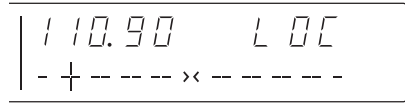

FIGURE 12
Nav display Active localizer frequency/
CDI format

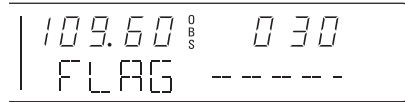

FIGURE 13
VOR flag display



FIGURE 14
VOR mode bearing to function

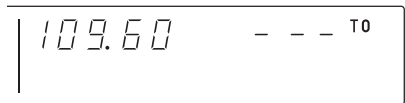

FIGURE 15
VOR mode active/bearing,
flag display

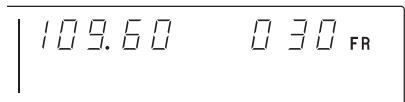

FIGURE 16
VOR mode
radial from function

increment/decrement knob channels the ACTIVE frequency window and depressing the frequency transfer button will cause the ACTIVE frequency to be placed in blind storage and the STANDBY frequency (in blind storage) to be displayed in the ACTIVE window display. In radial mode of operation, the right hand window of NAV display shows the radial FROM the station. Figure 16 illustrates the NAV side of the display in this mode:

When a too weak or invalid VOR signal is received the display flags as shown in Figure 17.

Another push of the mode button will cause the unit to go into the TIMER mode. See Figure 18. When the unit is turned on the elapsed timer begins counting upwards from zero. The timer can be stopped and reset to zero by pushing the NAV frequency transfer button for 2 seconds or more causing the ET on the display to flash. In this state the timer can be set as a countdown timer or the elapsed timer can be restarted. The countdown timer is set by using the NAV inc/dec knobs to set the desired time and then pushing the NAV frequency transfer button to start the timer. The outer knob selects minutes, the inner knob in the "in" position selects ten second intervals, and the inner knob in the "out" position selects individual seconds. After the countdown timer reaches zero, the counter will begin to count upwards indefinitely while flashing for the first 15 seconds. Or the elapsed timer can also be reset to zero and started again after it has been stopped and reset to zero by pushing the NAV frequency transfer button. The Audio Alert, if installed, is then sounded.

The NAV ACTIVE and STANDBY frequencies are stored in the memory on power down and return on power up.

When the smaller increment/decrement knob is pushed in, depressing the NAV TRANSFER button will interchange the ACTIVE and STANDBY frequencies. The NAV IDENT knob is active in the



FIGURE 17
VOR mode
active/radial flag display

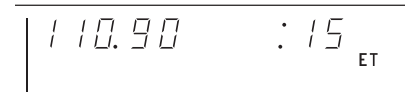

FIGURE 18
Timer mode

pulled out position so that both voice and ident can be heard. When this knob is pushed in, the ident tone is attenuated. The volume of voice/ident can be adjusted by turning this knob.

Pilot Configuration

This mode can be accessed by pressing and holding the Nav Mode Button for more than 2 seconds and then pressing the Nav Frequency Transfer Button for an additional 2 seconds, while continuing to hold the Nav Mode Button. When the Pilot Config Mode is entered the unit will show the "SWRV" mnemonic which is the unit software revision level. Adjustment pages can be accessed by MODE button presses.

The pilot may adjust two parameters in the pilot configuration, the display minimum brightness and sidetone volume level.

Minimum Brightness (BRIM) will have a range of 0 - 255. The dimmest is 0 and the brightest is 255.

Sidetone volume level is adjusted when SIDE is displayed. Values from 0 - 255 may be selected with 0 being least volume, 255 being the greatest.

Subsequent presses of the MODE button sequences through SWRV, BRIM, SIDE, and then back to SWRV.

Momentarily pressing the Nav Transfer Button exits Pilot configuration mode. The Nav returns to its pre-Pilot Config state with the new brightness and sidetone levels stored in non-volatile memory.

Default Mode

Turning on the KX 155A or KX 165A while pressing either the COMM or NAV frequency transfer button will bring the unit up in the Direct Tune Mode. 120.00MHz (120.000MHz in 8.33 kHz KX 165A) will be the active COMM frequency and 110.00 MHz will be the active NAV frequency. This will aid the pilot in blind tuning the radio in the unlikely event of display failure.

KN 53 Silver Crown TSO'd Navigation Receiver

Operating the KN 53

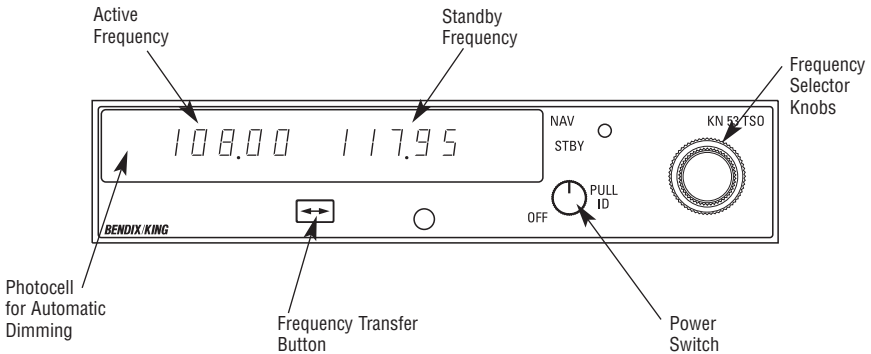

Power Switch

This knob controls ON/OFF/VOL/IDENT. To turn on the unit, rotate the knob clockwise from the detented OFF position. Rotation of this control also adjusts NAV audio volume. NAV voice can be heard when the knob is pushed in. When the knob is pulled out, the Morse Code IDENT signal plus voice can be heard.

Frequency Selection

By rotating the concentric frequency selector knobs either clockwise or counterclockwise, the desired operating frequency can be dialed into the standby display window. A clockwise rotation will increase the displayed frequency number, while a counterclockwise rotation will decrease it. The larger selector knob is used to change the MHz por-

tion of the frequency display; the smaller knob changes the kHz portion in 50 kHz steps. At either band edge of the 108.00 to 117.95 MHz frequency spectrum, an off-scale rotation will wrap the display around to the other frequency band-edge (i.e., 117.95 advances to 108.95 with MHz knob rotation, or 117.00 with kHz knob rotation). DME and optional internal glideslope channeling are also controlled by these selector knobs.

NAV Frequency Operation

The desired operating frequency is first entered into the standby display. To activate, push the transfer button. This will interchange the frequencies in the 'use' and 'standby' displays and tune the receiver to the new operating frequency.

This page intentionally left blank.

KN 62A and KN 64 TSO'd Silver Crown Digital DMEs

Operating the KN 62A and KN 64 DMEs

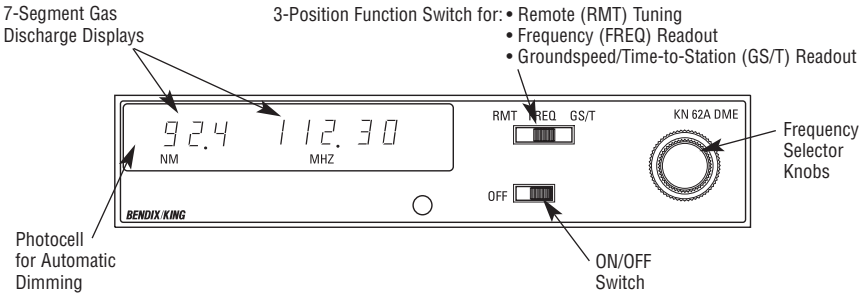

Operation

Turn on the unit only after engine start-up. Also, turn avionics off prior to engine shut-down. These simple precautions should be practiced with all avionics. It will protect the solid-state circuitry from short duration high voltage spikes and extend the operational life of your avionics.

The 3-position function switch determines both the information displayed and the channeling source.

Place the function switch on Frequency (FREQ). The unit is channeled internally with its own two concentric frequency selection knobs. The smaller of the two knobs has an "in" and an "out" position. When in the "in" position, this smaller knob changes the 0.1 MHz digit (0.0, 0.1, 0.2, etc.). When pulled "out", it adds 0.05 MHz to the frequency and tunes in 0.1 MHz steps (0.05, 0.15, 0.25, etc.). Pushing the smaller knob "in" subtracts 0.05 MHz from the displayed frequency. The outer, larger knob changes the larger digits (1 MHz, 10 MHz). In FREQ mode, the unit will display distance and the selected frequency. (See Figure 19.)

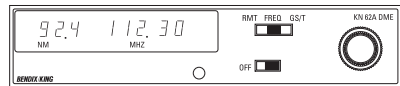

FIGURE 19.
Distance/Frequenc. FREQ Mode.

Now move the function switch to the Groundspeed/Time-to-Station (GS/T) position. The unit will hold the internally selected frequency and will display distance, groundspeed and time-to-station. (See Figure 20.)

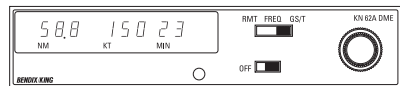

FIGURE 20.
Distance/Groundspeed/TTS GS/T Mode.

Rotating the frequency selector will have no effect on the display, because the DME is in "Frequency Hold". This frequency hold feature in the GS/T mode prevents accidental rechanneling of the DME when the frequency is not displayed.

Place the function switch in the Remote* (RMT) position, and your DME will be channeled when you

select your NAV frequency on the NAV receiver. Search time is usually about one second. When the unit locks on a ground station, it will display distance, groundspeed and time-to-station. (See Figure 21.)

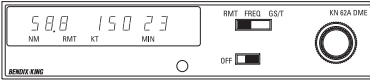

FIGURE 21.
Distance/Groundspeed/TTS RMT Mode.

Prior to lock on, “dashes” will be displayed. (See Figure 22.)

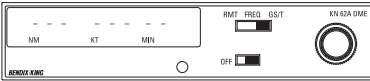

FIGURE 22.
Prior to Lock On.

Note that you may have two frequencies available at all times (one remotely selected on the NAV receiver and one internally selected with the unit's controls).

*Remote channeling requires wiring to the NAV receiver.

Operational Notes

The KN 62A and KN 64 have an audio output for use in identifying the DME ground station being received. The audio level is preset at the factory, but may be easily adjusted through the top cover.

The unit electronically converts to distance the elapsed time required for signals to travel to and from the ground station. This distance is then indicated in nautical miles on the Distance/Speed/Time-to-Station display. This distance, commonly referred to as slant range distance, should not be confused with actual along-the-ground distance. The difference between actual ground distance and slant range is least at low

altitude and/or long range. If the range is three times the altitude or greater, error is negligible.

The effective range of DME depends on many factors, most important being the altitude of the aircraft. Other contributing factors are the location and elevation of the station, DME transmitter power output, and receiver sensitivity.

The groundspeed feature incorporated in the unit measures the rate of change in DME slant range distance with time. This speed is then read from 0 to 999 knots in 1 knot increments. To obtain accurate groundspeed, the aircraft must be tracking directly to or from the station. To obtain accurate time to station, the aircraft must be tracking directly to the station.

KR 87 Silver Crown ADF System

Operating the KR 87

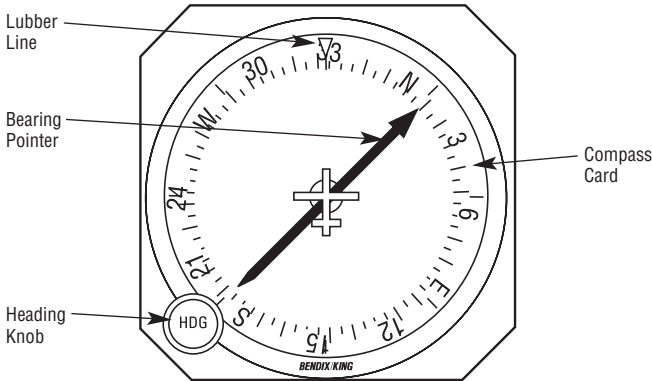
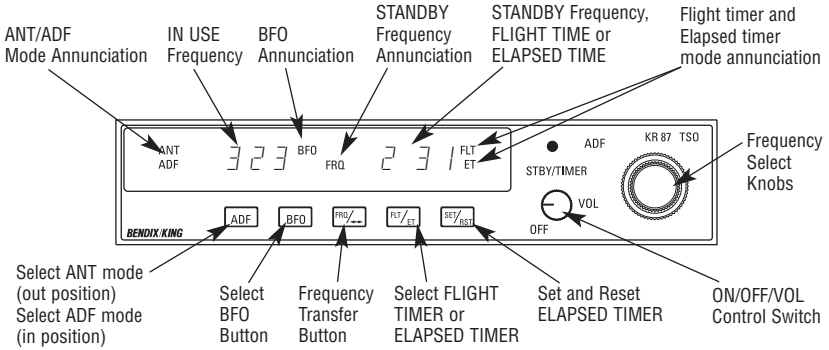

KI 227
KS 227-00 shown, non-slaved, standard
KI 227-01 slaved, optional

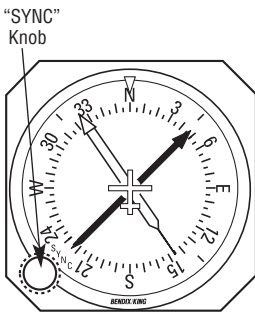

KI 228
Slaved KI 228-01 shown.
Standard KI 228-00 also available with manually rotatable compass card.

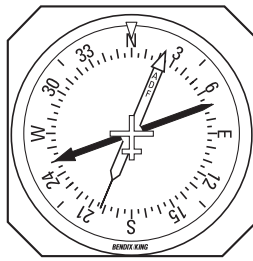

KI 229

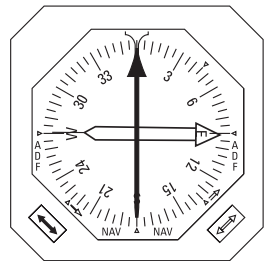

KNI 582

Turn-on

Rotate the ON/OFF/VOL knob clockwise from the detented "OFF" position. The unit will be activated and will be ready to operate. Rotation of this control also adjusts audio volume. The KR 87 has "audio muting" which causes the audio output to be muted unless the receiver is locked on a valid station.

Frequency Selection

The active frequency (to which the ADF is tuned) is displayed in the left side of the window at all times. A standby frequency is displayed in the right side when "FRQ" is annunciated. The standby frequency is placed in "blind" memory when either FLT (Flight Time) or ET (Elapsed Time) mode is selected.

With "FRQ" annunciated, the standby frequency is selected using the frequency select knobs which may be rotated either clockwise or counter-clockwise. Pull the small inner knob out to tune 1's. Push the smaller inner knob in to tune 10's. The outer knob tunes the 100's and the 1000's up to 1799.

The standby frequency selected may then be put into the active window by pressing the "FRQ" button. The standby and active frequencies will be exchanged (flip-flopped), the new frequency will become active, and the former active frequency will go into standby.

Operating Modes



Antenna (ANT) mode is selected and annunciated when the "ADF" button is in the "out" position. ANT provides improved audio reception from the station tuned and is usually used for identification. The bearing pointer in the KI 227 indicator will be deactivated

and immediately turn to the 90° relative position and remain there during ANT reception.



The ADF mode is selected and annunciated when the "ADF" button is in the depressed position. ADF activates the bearing pointer in the KI 227 indicator, causing it to move without hesitation to point in the direction of the station relative to the aircraft heading. The compass card on the KI 227 may be rotated as desired by using the heading knob.

NOTE: The KI 227-01 or KI 228-01 indicators, when installed with a Bendix/King KCS 55A Compass System, have a slaved compass card. Magnetic heading of the aircraft will be under the lubber line. **The indication of this compass card should be compared with that of the KI 525A master indicator from time to time. Check especially after steep bank turns and taxi turns. If a discrepancy between the two readings exists, the KI 227-01 or KI 228-01 compass card should be synchronized to the KI 525A compass card by rotating the "SYNC" knob on the indicator.**



Outside of the United States some stations are unmodulated and use an interrupted carrier for identification purposes. The BFO mode, activated and annunciated when the "BFO" button is depressed, permits the carrier wave and the associated Morse code identifier broadcast on the carrier wave to be heard.

ADF Test

(PRE-FLIGHT OR IN-FLIGHT)

Select ANT mode. This will cause the bearing pointer to move directly to

the parked 90° position. Make sure the unit is tuned to a usable frequency. Now select ADF mode and the needle should move without hesitation to the station bearing. Excessive sluggishness, wavering or reversals indicate a signal that is too weak or a system malfunction.

Operating the Timers

The flight timer will always be automatically reset to :00 whenever power is interrupted either by the avionics master switch or the unit's ON/OFF switch. An optional external switch may be installed which, when activated, will stop or start the flight timer. This switch would be of use during a non-refueling stop when resetting the flight timer is not desired. On some aircraft it may be desirable to use the aircraft strut switch instead of a manual switch to stop and start the flight timer. It should be emphasized that the start/stop function will only operate with power applied to the unit. Always read flight time prior to power shutdown.



Flight time or elapsed time are displayed and annunciated alternatively by depressing the FLT/ET button. The flight timer continues to count up until the unit is turned off or stopped with an external switch. The elapsed timer may be reset back to :00 by pressing the SET/RST button. It will then start counting up again. (NOTE: pressing the SET/RST button will reset the elapsed timer whether it is being displayed or not.)



The elapsed timer also has a “count-down” mode. To enter the countdown mode, the SET/RST button is depressed for about two seconds, or

until the “ET” annunciation begins to flash. It is now in the ET set mode, and a time up to 59 minutes, 59 seconds may be preset into the elapsed timer with the concentric knobs. The preset time will be displayed and remain unchanged until SET/RST is pressed again, which will start the elapsed timer counting down from the preset time. When the timer reaches :00 it will start to count up as the display flashes for 15 seconds and an aural alarm, if installed, is activated for about 1 second.

NOTE: The standby frequency which is in memory while flight time or elapsed time modes are being displayed may be called back by pressing the FRQ button, then transferred to active use by pressing the FRQ button again.

While FLT or ET is displayed the “in use” frequency on the left side of the window may be changed, by using the frequency select knobs, without any effect on the stored standby frequency or the other modes. This feature is especially useful when searching for stations with unknown frequencies.

Erroneous ADF Bearings Due to Radio Frequency Phenomena

Station Overlap

In the U.S., the FCC, which assigns AM radio frequencies, occasionally will assign the same frequency to more than one station in an area. Certain conditions, such as Night Effect, may cause signals from such stations to overlap. This should be taken into consideration when using AM broadcast stations for navigation.

Sunspots and atmospheric phenomena may occasionally distort reception so that signals from two stations on the same frequency will overlap. For this reason it is always wise to make positive identification of the station being tuned, by switching the function selector to ANT and listening for station call letters.

Electrical Storms

In the vicinity of electrical storms, an ADF Indicator pointer tends to swing from the station tuned toward the electrical discharges. Location of the storm can be useful information, but the erratic behavior of the pointer should be taken into account.

Night Effect

This is a disturbance particularly strong just after sunset and just after dawn. An ADF indicator pointer may swing erratically at these times. If possible, tune to the most powerful station at the lowest frequency. If this is not possible, take the average of pointer oscillations to determine relative station bearing.

Mountain Effect

Radio waves reflecting from the surface of mountains may cause the pointer to fluctuate or show an erroneous bearing. This should be taken into account when taking bearings over mountainous terrain.

Coastal Refraction

Radio waves may be refracted when passing from land to sea or when moving parallel to the coastline. This should be taken into account when operating near coastal areas.

KT 76C

Bendix/King Panel-Mounted Transponder

KT 76C OPERATION

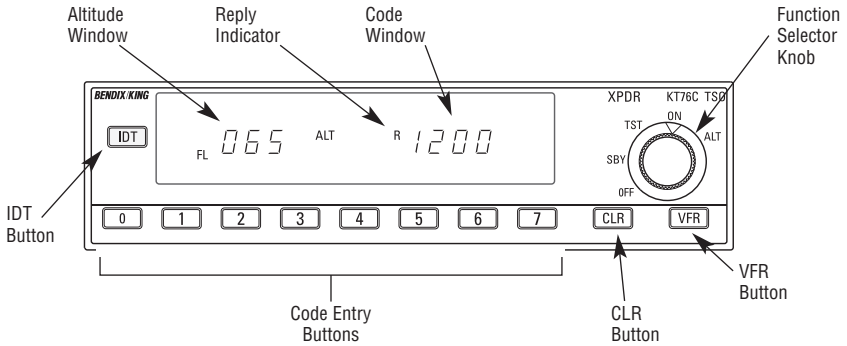

About Transponders

Your Honeywell Bendix/King transponder is a radio transmitter and receiver which operates on radar frequencies. Receiving ground radar interrogations at 1030 MHz, it returns a coded response of pulses to ground-based radar on a frequency of 1090 MHz.

As with other Mode A/Mode C transponders, the KT 76C replies with any one of 4,096 codes, which differ in the position and number of pulses transmitted. By "replying" to ground transmissions, your KT 76C enables ATC computers to display aircraft identification, altitude and ground speed on Enroute, Approach or Departure Control radar screens. When the IDENT button is pressed, your aircraft will be positively identified to the Air Traffic Controller.

Operating the KT 76C

Before starting your aircraft's engine, make sure that the KT 76C function selector knob, or your avionics master, is turned to OFF. After engine start, turn the function selector knob to SBY (standby). Give your transponder about 45 seconds to become opera-

tional. Select the proper reply code by pressing the desired code entry buttons. The reply code will be displayed in the code window. Before takeoff, rotate the function selector knob to the ALT (altitude) position for Mode C altitude reporting to ATC. If you do not have an encoding altimeter, rotate the function switch to ON for Mode A reporting.

Altitude Display

The KT 76C displays Flight Level Altitude, marked by the letters "FL" and a number in hundreds of feet, on the left side of the display. For example, the reading "FL 065" corresponds to the altitude of 6,500 feet, referenced to 29.92 inches of mercury (or 1013 hPa) at sea level. Flight Level Altitude represents "pressure altitude," and should not be confused with true altitude. Please note that the displayed altitude may not agree exactly with the aircraft's altimeter when flying below 18,000 feet, because encoders are preset to 29.92 inches of mercury. An encoder's altitude transmission is automatically corrected for proper altimeter setting by a ground based computer, to present the correct altitude to the controller.

Ranging from -1,000 to +99,000 feet, Flight Level Altitude is displayed only when altitude reporting is enabled. If the altitude window is blank or shows a series of dashes (as in the case of an invalid altimeter code being reported), altitude reporting will be disabled.

CLR Button

Code entry mistakes are corrected, one digit at a time, by pressing the CLR button and reentering the correct code. The last active code will be displayed if a complete four-digit code has not been entered and there is no activity on any of the code entry buttons, the VFR button, or the CLR button for four seconds.

VFR Button

Momentarily pressing the VFR button will enter a pre-programmed VFR code, typically 1200, in the code window. Pressing and holding the VFR button for two seconds will cause the last active code to be displayed.

During installation, it may be desired to set the default VFR code to a code other than 1200. The VFR code is programmed by the following sequence:

1. Place the unit in standby.
2. Enter the desired VFR code with the ident code pushbutton switches.
3. Depress the "VFR" pushbutton while holding the "IDT" pushbutton in its depressed position.

Reply Indicator

The reply indicator blinks to indicate that the KT 76C is functioning properly and replying to interrogations.

Squawk Ident

When you are asked to "ident" by ATC, press the IDT button. The reply indicator will illuminate continuously for 18 seconds during the ident interval.

Important Codes

7700 - Emergency

7600 - Communication Failure

7500 - Hijacking

0000 - Military - **DO NOT USE!**

See the Aeronautical Information Manual (AIM) for detailed explanation of these codes and their use.

KT 70 and KT 71 Panel-Mounted Transponders

Operating the KT 70 and KT 71

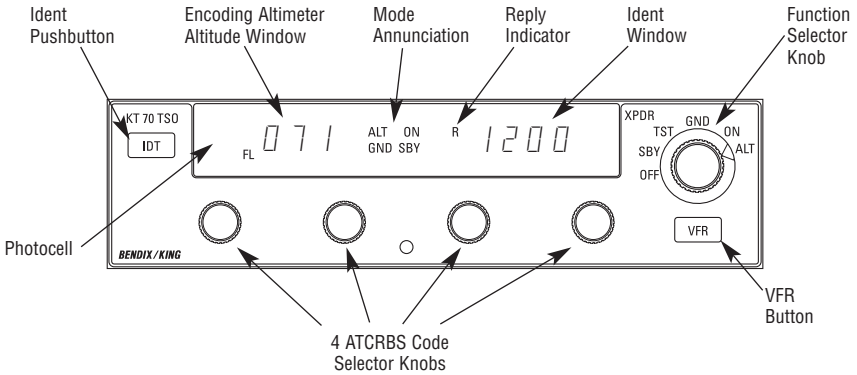

IDENT Button

Marked IDT, the KT 70/71's Ident button is pressed when ATC requests an "Ident" or "Squawk Ident" from your aircraft. When the Ident button is pressed, the reply indicator, an "R"-shaped annunciator light will glow for approximately 18 seconds. An optional Remote Ident switch may also be installed to perform the same function.

ID Code

The ATCRBS Transponder Identification code (squawk code) for the aircraft is displayed in the Ident Window on the right side of the display. Each of the four Transponder Code Selector Knobs selects a separate digit of the identification code.

Reply

The lighted "R" reply indicator blinks when the transponder is replying to a valid interrogation and illuminates for 18 seconds after the initiation of the Ident.

Altitude Display

The KT 70 and KT 71 display Flight Level Altitude, marked by the letters "FL" and a number in hundreds of feet,

on the left side of the display. For example, the reading "FL 071" corresponds to an altitude of 7,100 feet, referenced to 29.92 inches of mercury (or 1013 hPa) at sea level. Flight Level Altitude represents "pressure altitude", and should not be confused with true altitude. Please note that the displayed altitude may not agree exactly with the aircraft's altimeter when flying below 18,000 feet, because encoders are preset to 29.92 inches of mercury. An encoder's altitude transmission is automatically corrected for proper altimeter setting by a ground-based computer, to present the correct altitude to the controller.

Ranging from -1,000 to +99,900 feet, Flight Level Altitude is displayed only when altitude reporting is enabled. If the altitude window is blank or shows a series of dashes (as in the case of an invalid altimeter code being reported), altitude reporting will be disabled.

VFR

Momentarily pressing the VFR Pushbutton/Function Selector Knob recalls the preprogrammed VFR code, superseding whatever code was previously entered. If the VFR Pushbutton

is pressed inadvertently, the previous code may be retrieved by pressing the Function Selector Knob and holding it for two seconds.

If a preset VFR code other than the factory-set 1200 is desired, a new code may be programmed as follows:

1. Place the unit in Standby (SBY)
2. Select the desired VFR code
3. While holding the IDT (Ident) button in, momentarily press the VFR button (Function Selector Knob).

Function Selector Knob

The Function Selector Knob on the right side of the KT 70 and KT 71 enables you to choose from among the following operating modes:

OFF - The unit is not receiving power. **For the KT 70 only**, when the unit is turned to another mode, the installer-programmed aircraft address and the aircraft's maximum airspeed will be displayed, according to the following sequence:

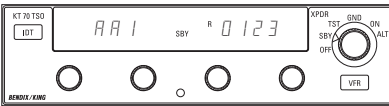

- 1.) The "FL" window will display "AA1", while, for two seconds, the Ident window will display the first four digits of the unique aircraft address code.

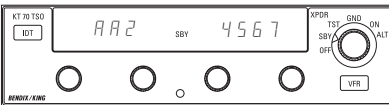

- 2.) The "FL" window will display "AA2" and the Ident window will display the last four digits of the aircraft address code.

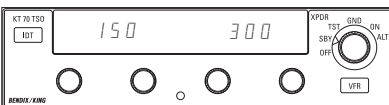

- 3.) The "FL" window will display the lower limit and the Ident window the

upper limit of the preprogrammed air-speed range, again for two seconds. The six programmable ranges include 0-75, 75-150, 150-300, 300-600, 600-1200 and greater than 1200 knots.

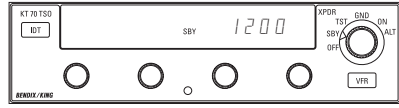

SBY (STANDBY) - In Standby on both the KT 70 and KT 71, the unit is energized but is inhibited from replying to any interrogation. "SBY" is shown on the display, while the altitude display is disabled.

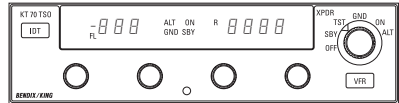

TST (TEST) - Replies are disabled in test mode, and the unit illuminates all segments of the display for at least four seconds. A series of internal tests is performed to check the KT 70/71's integrity, verifying all EEPROM data and making hardware and squitter checks.

Should a squitter error occur, the transmitter is considered inoperative, and the message "F01" will appear on the altitude display. Should an EEPROM error be detected, the messages "F02" (internal) or "F03" (external) will appear. If the KT 70 or KT 71 detect a hardware failure that prohibits normal operation, the message "F04" will be shown. If no errors are detected, the unit remains in test mode.

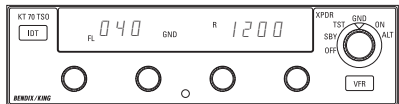

GND (GROUND) - In the KT 71, all interrogations are inhibited. In the KT 70, ATCRBS (Air Traffic Control Radar Beacon System) Mode A&C interrogations are inhibited, but the KT 70 will reply to all valid Mode S interrogations,

provided a Mode S status bit is set to indicate the aircraft is on the ground. In both units, the ID code is shown on the right side of the display, with altitude reported on the left side. The letters "GND" are also displayed in this mode.

NOTE: An optional remote "air/ground" switch may be installed on the aircraft's landing gear strut to keep the KT 70 and KT 71 in the GND mode until the airplane is airborne. This feature eliminates the need to activate the unit's ON or ALT modes after takeoff.

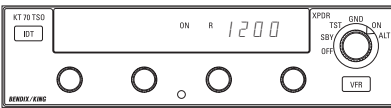

ON - The KT 70 is able to reply to all valid Mode A, C and S interrogations (Mode A and C on the KT 71). However, the altitude information will not be transmitted. In the ON mode, the altitude window is left blank, the ID code is shown on the right and the "ON" annunciation is shown on the display.

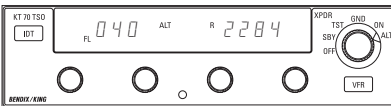

ALT - In the "ALTITUDE" mode, the KT 70 replies to all valid Mode A, C and S interrogations (Mode A and C on the KT 71). The ID code is displayed in the right window and altitude information (in hundreds of feet) is shown on the left.

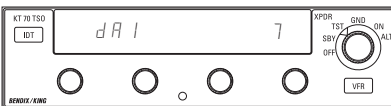

DISPLAY ADJUST MODE - The KT 70's and 71's displays feature three programmable adjustments: dA 1, dA 2 and dA 3. Display Adjust 1 (dA 1) is used to vary the dim/bright response time to changes in ambient light. A set-

ting of 1 provides immediate display brightness changes when there are changes in the light falling on the photocell. With dA 1 set to a value of 8, the response time is approximately eight seconds. dA 1 values of 2 through 7 provide intermediate response times. The factory setting is 1.

Display Adjust 2 (dA 2) is used to vary the display brightness when ambient light conditions are less than direct sunlight, such as in a dark cockpit at night. The factory setting is 20.

Display Adjust 3 (dA 3) varies the amount of ambient light required for the display to reach its full dim and bright levels. A common use of dA 3 is to adjust the KT 70 and KT 71 display brightness to match the brightness of other radios' displays and to provide display brightness compensation as the display ages. The factory setting is 0.

The following steps allow you to access these adjustments:

1. Turn the Function Selector Knob to TST.
2. Press and hold the IDT button for five seconds, until "dA 1" appears in the altitude window.
3. Select the desired display adjustment (dA 1, dA 2, dA 3) by pressing the VFR pushbutton.
4. Set the desired adjustment value in the IDENT window, using the Ident Code Selector Knob on the far right. Note the settings below:
 - dA 1 (Photocell response):
 - 1-8, 1=Fastest, 8=Slowest
 - dA 2 (Display brightness):
 - 0-64, 0=Dimmest, 64=Brightest
 - dA 3 (Vendor/Age compensation):
 - 0-255, 0=Normal/Dimmest, 255=Brightest
5. Press the IDT pushbutton or turn the Function Selector Knob to exit the display adjust mode, saving the new values.

This page intentionally left blank.

KT 73 Mode S, Datalink Transponder

Operating the KT 73

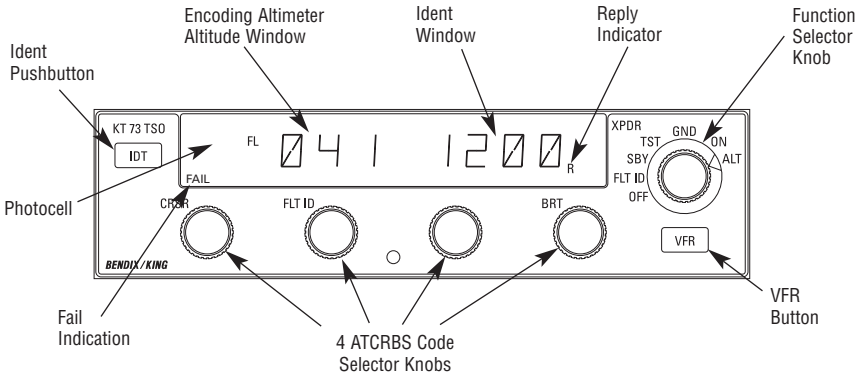

IDENT Button

Marked IDT, the KT 73's Ident button is pressed when ATC requests an "Ident" or "Squawk Ident" from your aircraft. When the Ident button is pressed while in the GND, ON or ALT modes, "IDT" will be illuminated on the display for approximately 18 seconds. An optional Remote Ident switch may also be installed to perform the same function.

ID CODE

The ATCRBS Transponder Identification code (squawk code) for the aircraft is displayed in the Ident Window on the right side of the display. Each of the four Transponder Code Selector Knobs selects a separate digit of the identification code.

REPLY INDICATOR

When the KT 73 is replying to a valid ground Mode S interrogation, the reply nomenclature "R" will be illuminated twice per second. When the KT 73 is replying to a valid ATCRBS or airborne Mode S interrogation, the reply nomenclature "R" will be illuminated once per second.

ALTITUDE DISPLAY

When the ALT mode is selected, the KT 73 displays the current Flight Level, marked by the letters "FL" and a number in hundreds of feet. This is shown on the left side of the display. For example, if "FL 071" is displayed, this corresponds to a reported pressure altitude of 7,100 feet. Note that the displayed Flight Level, or pressure altitude, may not agree with the aircraft's baro-corrected altitude under non-standard conditions. The Flight Level, or pressure altitude, reported by the KT 73 will be corrected as required by the ATC facility.

A fault in the altitude interface or an invalid altitude input to the KT 73 will cause the display to show a series of dashes when the KT 73 is in the ALT mode.

VFR

Momentarily pressing the VFR Pushbutton recalls the preprogrammed VFR code, superseding whatever code was previously entered. If the VFR Pushbutton is pressed inadvertently, the previous code may be retrieved by

pressing the VFR button and holding it for two seconds.

If a preset VFR code other than the factory-set 1200 is desired, a new code may be programmed as follows:

1. Place the unit in Standby (SBY)
2. Select the desired VFR code
3. While holding the IDT (Ident) button in, momentarily press the VFR button.

FUNCTION SELECTOR KNOB

The Function Selector Knob on the right side of the KT 73 enables you to choose from the following operating modes:

OFF - The unit is not receiving power. When the unit is turned to another mode, it will reply or squitter within two seconds, according to the selected mode.



FLT ID (FLIGHT ID) - The Flight ID should be the aircraft identification employed in the flight plan. When no flight plan is available, the registration marking of the aircraft should be used. When the FLT ID mode is selected, the KT 73 is inhibited from replying to any interrogation, "FLT ID" is annunciated on the display and the flight ID is displayed. The Flight ID is modified by rotating the CRSR knob to position the cursor (▲) under the character to be changed then rotating the FLT ID knob to select the desired character. Once the CRSR and FLT ID knobs have been idle for 5 seconds or the mode select knob has been turned to the SBY position the flight ID will be saved.

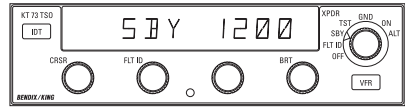

SBY (STANDBY) - In Standby, the unit is energized but is inhibited from replying to any interrogation. "SBY" is shown on the left side of the display and the ID code is shown on the right.

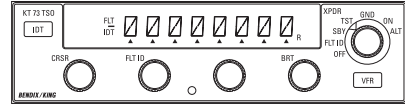

TST (TEST) - Replies are disabled and all display segments are illuminated for at least four seconds. A series of internal tests is performed to check the KT 73's integrity, verifying all aircraft specific configuration data and make hardware and squitter checks. If no faults are detected, "TEST OK" is displayed and an audio message "TEST OK" is annunciated, if the audio function is installed.

The audio volume is set during installation. Contact your avionics installer to adjust the volume level to your personal preference.

Should a fault be detected, "SBY" will be displayed on the left and the display on the right will cycle through all the detected faults. If the faults are associated with external data, an audio message "CHECK FAULT CODES" will be annunciated. Faults internal to the KT 73 will annunciate an audio message "TRANSPONDER TEST FAIL". Internal faults will also cause "FAIL" to be annunciated in the lower left of the display in any mode of operation.

The fault codes are as follows:

- F1YY* - Squitter (Internal)
- F2YY* - Internal or External EEPROM (Internal)
- F3YY* - Hardware (Internal)
- F401 - Mode S address/Max Airspeed (Internal)
- F5YY* - Gilham or Executive (External)
- F6YY* - Interface (External)

* YY denotes the specific fault.

Except for the acquisition data fault (code 101), the KT 73 will not inhibit replies when an internal fault is identified.



GND (GROUND) - The KT 73 will inhibit ATRCBS (Air Traffic Control Radar Beacon System), ATRCBS/Mode S All Call and Mode S-only All Call replies. However, the unit will continue to generate Mode S squitter transmissions and reply to discretely addressed Mode S interrogations. The ID code is shown on the right side of the display and the letters "GND" are shown on the left side.

Note: An optional remote "air/ground" switch may be installed. This feature eliminates the need to manually place the KT 73 in the GND mode. In addition, when the aircraft is airborne, the KT 73 will function as though the Function Selector Knob is in the ALT position when it is actually in the GND position.



ON - The KT 73 is able to reply to all valid Mode A, C and S interrogations. However, the altitude information will not be transmitted. In the ON mode, the altitude window is left blank and the ID code is shown on the right side of the display.



ALT (ALTITUDE) - The KT 73 replies to all valid Mode A, C and S interrogations. The ID code is displayed in the

right window and altitude information (in hundreds of feet) is shown on the left. The letters "FL" will be illuminated, indicating Flight Level. If altitude information is unavailable or invalid, the left portion of the display will be dashed.

DISPLAY BRIGHTNESS ADJUST-

MENT - The KT 73's display brightness is controlled by an ambient light sensor. In addition, it has a manual adjustment to allow for matching to the brightness of other lighted displays that may be in the cockpit. The display is adjusted in the test (TST) mode.

To manually adjust the display brightness, perform the following operations:

1. Turn the Function Selector Knob to "TST".
2. Turn the BRT knob clockwise to increase the display brightness, or counterclockwise to decrease the display brightness.

The eight carets below the alphanumeric display characters indicate the brightness setting (relative to the photocell reading). Maximum brightness is indicated by all eight carets being illuminated. Minimum brightness is indicated by no carets being illuminated. The factory default setting is represented by four carets being illuminated. Pressing the IDT button will return the brightness to the default factory value.

3. Turn the Function Selector Knob from TST to store the display brightness settings.

NOTE: If power is removed from the KT 73 while still in the test mode, the brightness setting will be lost and the unit will revert to the last known setting.

This page intentionally left blank.

Honeywell International Inc.
One Technology Center
23500 West 105th Street
Olathe, KS 66061
Telephone (913) 782-0400
FAX 913-712-1302

©1998-2002 Honeywell International Inc.
006-18110-0000 Printed in U.S.A.
Revision 4 Nov/2002

Honeywell